



INSTALLATION GUIDE

Photovoltaic Module(Single-glass)



TABLE OF CONTENTS

1 GENERAL INFORMATION	2
1.1 APPLICABLE PRODUCTS	2
1.2 PRODUCT IDENTIFICATION	2
2 SAFETY	3
2.1 GENERAL SAFETY	3
2.2 HANDLING SAFETY	3
2.3 INSTALLATION SAFETY	4
2.4 FIRE SAFETY	4
3 INSTALLATION	5
3.1 GENERAL INSTALLATION PRINCIPLE	5
3.2 LOCATION AND ANGLE SELECTION	6
3.3 SCREW INSTALLATION	6
3.4 CLAMP INSTALLATION	7
3.5 TRACKER INSTALLATION	9
3.6 OTHER INSTALLATION	9
3.7 ELECTRICAL INSTALLATION	10
3.8 GROUNDING	11
4 MAINTENANCE	11
4.1 CLEANING	12
4.2 THE VISUAL INSPECTION OF THE MODULES	13
4.3 INSPECTION OF THE CONNECTOR AND CABLE	13
5 PARAMETERS	13

WARNING!

The photovoltaic module produces electricity when exposed to the sun or other light sources. For your safety and the safety of others, please read the entire installation and assembly instruction manual carefully prior to installation. Please carefully read the following installation and safety instructions. Non-compliance with these instructions may void the module warranty.

1 GENERAL INFORMATION

Thanks for choosing SEG Solar Photovoltaic Modules (hereafter referred to as “PV Module”), This Guide is to give information on how to apply SEG Solar PV modules properly.

Installers must read and understand this Guide prior to installation. For any questions, please contact our technical department (technic@segsolar.com) for further information. Installers should follow all safety precautions described in this Guide as well as local codes when installing a module.

Keep this Guide in a safe place for future reference (care and maintenance) and in case of sale or disposal of the PV modules.

1.1 APPLICABLE PRODUCTS

This document is applicable to the series of PV modules as listed below:

Type 1 166	SEG-XXX-BMB-HV/TB (1755×1038×35, 1776×1052×35)
	SEG-XXX-BMA-HV/TB (2094×1038×35, 2115×1052×35)
Type 2 182	SEG-XXX-BMD-HV/TB, SEG-XXX-BTD-HV/TB (1722×1134×35/30)
	SEG-XXX-BMB-HV/TB, SEG-XXX-BTB-HV/TB (1909×1134×35)
	SEG-XXX-BMA-HV/TB, SEG-XXX-BTA-HV/TB (2278×1134×35)
Type 3 210	SEG-XXX-BMC-HV/TB, SEG-XXX-BTC-HV/TB (2384×1303×35)
	SEG-XXX-BMB-HV/TB, SEG-XXX-BTB-HV/TB (2172×1303×35)
Type 4 156&158.75	SEG-XXX-6MA-HV/TB, SEG-XXX-6PA-HV/TB 1956(1970 or 1985)×992(1002)×40/35
	SEG-XXX-6MB-HV/TB, SEG-XXX-6PB-HV/TB 1640(1650 or 1665)×992(1002)×35/30
	SEG-XXX-BMA-HV/TB (2015×1002×40/35)
	SEG-XXX-BMB-HV/TB (1690×1002×35)
	SEG-XXX-BMZ-HV/TB (2180×1002×40/35)

1.2 PRODUCT IDENTIFICATION

Each module has three Barcode stickers and one label which have the same unique serial no. of each module.

Barcode 1: Laminated into PV modules.

Barcode 2: Sticker on the backside of PV modules.

Barcode 3: Sticker on the middle location of long frame side.

Label: Sticker on the backside of PV modules, contains model no. and specific information pertaining to the module.

Check the serial No. in the barcode with the packing list when unpacking. Provide the PV module serial No. When you need support from SEG SOLAR for a particular PV module.

2 SAFETY

2.1 GENERAL SAFETY

Be careful when unpacking, transporting, and storing the modules. They are subject to breakage if they are not handled and installed properly. It is recommended not to take them out of the packaging until the moment of the installation. During installation, please use soft materials to protect the modules from contacting directly with the ground, concrete or tiles. Otherwise scratches or glass breakages may occur.

- The PV module is used in systems operating at greater than 50 VDC or 240 W where general access is anticipated. The PV module is certified for safety through UL 61730 and within this application class are also certified to meet the requirements for fire safety Type 1 or 29.
- The PV modules shall be properly grounded in accordance with the instructions in this Guide or the requirements of the National Electrical Code.
- Installing PV modules requires specialized skills and knowledge. Installation should only be performed by qualified personnel, electrical connections require a licensed electrician, where applicable according to local code and law (i.e., the NEC for the USA and CEC for Canada).
- Installers should assume all risk of injury that might occur during installation, including, but not limited to, the risk of electric shock.
- One single PV module may generate more than 30V DC when exposed to direct sunlight. Access to a DC voltage of 30V or more is potentially hazardous.
- PV modules convert light energy to DC electrical energy, which are designed for outdoor use. PV modules can be mounted onto ground, rooftop, vehicles or boats etc. The proper design of support structures lies within responsibility of the system designers and installers.
- Do not use mirrors or other magnifiers to concentrate sunlight onto the PV modules.
- When installing the PV modules, abide to all local, regional and national statutory regulations. Obtain a building permit if necessary.
- Only use equipment, connectors, wiring and support frames compatible with the PV modules.
- Do not clean the modules with chemicals.
- Storage Temperature: $-10^{\circ}\text{C} \sim 40^{\circ}\text{C}$, Storage Humidity: $\leq 70\% \text{RH}$.
- Modules should operate at environmental temperature of between -40 to $+85^{\circ}\text{C}$.

2.2 HANDLING SAFETY

- Do not lift the PV module by grasping the module's junction box or electrical leads.
- Do not stand or step on the PV modules or place heavy objects onto it.
- Do not drop the PV module or allow objects to fall on the PV module.
- Do handle with care when moving, transporting and installing the PV module.
- Do not attempt to disassemble the PV modules and do not remove any attached nameplates or components.
- Do not apply paint or adhesive to the PV module top surface.
- Do not scratch or hit the back sheet.
- Do not drill holes in the frame. This may reduce the frame mechanical strength and cause cells to crack due to vibration.
- Do not break the anodized coating of the frame (except for grounding connection), this may cause corrosion of the frame.
- Do not use PV modules with broken glass or torn back sheet which presents danger of electrical shock.
- Do not handle panels in wet conditions without appropriate protection.
- Do not expose PV module to sunlight until installation to avoid unnecessary degradation.

2.3 INSTALLATION SAFETY

- Any module without a frame (laminated) shall not be considered to comply with the requirements of UL61730 unless the module is mounted with hardware that has been tested and evaluated with the module under this standard or by a field inspection certifying that the installed module complies with the requirements of UL61730.

- Installation shall conform with UL standards and Safety Standards for Electrical Installations.
- Do not disconnect under load.
- Do not touch conductive parts of PV modules, such as terminals, which can result in burns, sparks and lethal shock whether or not the PV module is connected.
- Do not touch the PV module unnecessarily during installation.
- Do not work in the rain, snow or windy conditions.
- Do not expose artificial sunlight to PV modules. Completely cover the PV module with an opaque material during installation to prevent electricity from being generated.
- Do not wear metallic rings, watchbands, ear, nose, lip rings or other metallic objects while installing or troubleshooting.
- Only use insulated tools that are qualified for working on electrical installations.
- Follow the safety regulations for all other system components, including wire and cables, connectors, charging regulators, inverters, storage batteries, rechargeable batteries, etc.
- Under normal outdoor conditions the current and voltage generated will differ from those listed on the datasheet. Current and short-circuit current should be multiplied by a factor of 1.25 to determine component ratings.
- Only use connectors compatible with the PV module connectors. Removing the connectors without prior authorization will invalidate the warranty.
- Do not move installed modules to another location, which may invalidate the warranty.
- Do not install modules within 50m of the shoreline.

2.4 FIRE SAFETY

- The fire rating for this module is only valid when the product is installed as specified in the mechanical mounting instructions in this document.
- The fire rating of this module is valid only if this Guide is followed.
- Consult your local authority for Guidelines and requirements for building or structural fire safety.
- Do not use PV modules near equipment or in places where flammable gases may be generated.
- Follow local codes and laws when installing the modules
- Roof construction and installation may affect the fire safety of a building; Improper installation may create a hazard in the event of a fire.
- Do not install module that is damaged in any way as it can pose a fire or electrical shock hazard.

3 INSTALLATION

3.1 GENERAL INSTALLATION PRINCIPLE

- Modules can be installed in both landscape and portrait modes(as shown in table 1).

Module type	Wiring configurations
<p>Type 1 166</p> <p>SEG-XXX-BMB-HV/TB</p> <p>SEG-XXX-BMA-HV/TB</p>	 <p style="text-align: center;">Portrait installation one row</p>
<p>Type 2 182</p> <p>SEG-XXX-BMD-HV/TB</p> <p>SEG-XXX-BTD-HV/TB</p> <p>SEG-XXX-BMB-HV/TB</p> <p>SEG-XXX-BTB-HV/TB</p> <p>SEG-XXX-BMA-HV/TB</p> <p>SEG-XXX-BTA-HV/TB</p>	 <p style="text-align: center;">Portrait installation two rows</p>
<p>Type 3 210</p> <p>SEG-XXX-BMC-HV/TB</p> <p>SEG-XXX-BTC-HV/TB</p> <p>SEG-XXX-BMB-HV/TB</p> <p>SEG-XXX-BTB-HV/TB</p>	 <p style="text-align: center;">Landscape installation one row</p>
<p>Type 4 156&158.75</p> <p>SEG-XXX-6MB-HV/TB</p> <p>SEG-XXX-6PB-HV/TB</p> <p>SEG-XXX-BMB-HV/TB</p> <p>SEG-XXX-6MA-HV/TB</p> <p>SEG-XXX-6PA-HV/TB</p> <p>SEG-XXX-BMA-HV/TB</p> <p>SEG-XXX-BMZ-HV/TB</p>	 <p style="text-align: center;">Landscape installation two rows</p>

Table 1

- The PV modules shall be installed high enough to keep it away from potential shading, windblown sand, snow and water.
- It is recommended that installation of the PV modules be 30cm away from the ground to insure adequate ventilation.
- Appropriate installation structure shall be chosen to meet required mechanical load.
- It is recommended that PV modules be installed with a minimum tilt angle of 10 degrees to facilitate cleaning and washdown.
- It is recommended to maintain minimum 10mm gap between PV modules for thermal expansion of materials.
- Install PV modules appropriately according to corresponding mechanical load needs.

3.2 LOCATION AND ANGLE SELECTION

It is recommended that PV modules be installed where there is excellent solar insolation. In the Northern Hemisphere, the module should typically face south, and in the Southern Hemisphere, the modules should typically face north. The most optimum installation angle varies according to different latitudes and longitudes; please consult experts with appropriate knowledge backgrounds when determining the installation locations and angles.

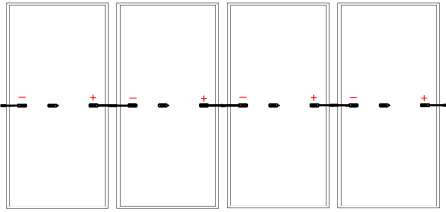
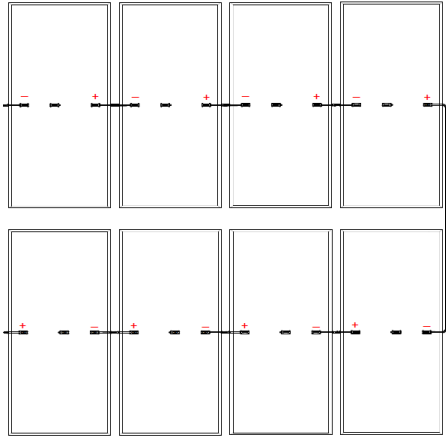
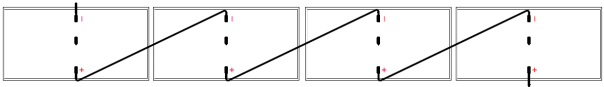
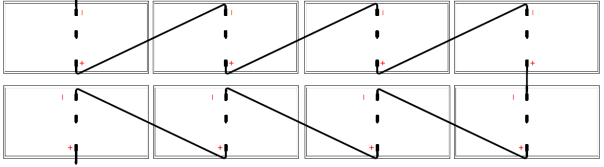
When choosing a site, avoid trees, buildings, or obstructions which could cast shadows on the solar photovoltaic modules. Shading can cause hot spots and loss of output. Factory-fitted bypass diodes will minimize such effect.

Do not install the PV modules near naked flame or flammable materials.

Do not install the PV modules in a location where they would be immersed in water or constantly exposed to water from a sprinkler or fountain etc.

3.3 SCREW INSTALLATION

The single glass module with frame is designed for screw installation. It needs the screws, bolts, nuts, and washers to fix the bracket(as shown in Fig 1). Sufficient torque should be applied to the bolts to ensure stable reinforcement. The reference torque value for M8 screw is 16~20N*M. The reference torque value for M6 screw is 9~12N*M.

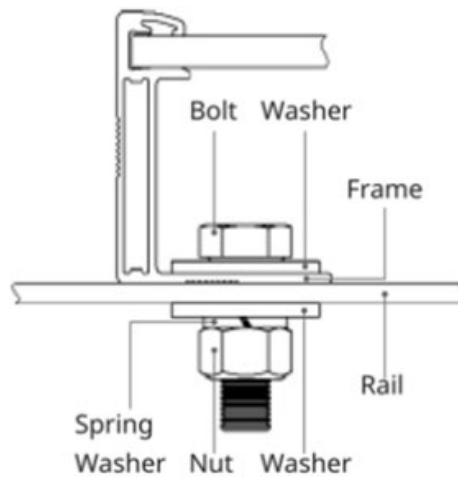

Figure 1 Screw installation

Mounting hole(mm)	Recommended bolt size
14×9	M8
10×7	M6

Bolts for different mounting holes

Module type		Load (Pa)			Installation Drawing
Type 1 166	SEG-XXX-BMB-HV/TB SEG-XXX-BMA-HV/TB	+5400/ -2400 (8 holes)	+2400/ -2400 (Outer 4 holes)	+2400/ -2400 (Inner 4 holes)	<p>8 mounting holes</p>
Type 2 182	SEG-XXX-BMB-HV/TB SEG-XXX-BTB-HV/TB				
Type 4 156&158.75	SEG-XXX-6MB-HV/TB SEG-XXX-6PB-HV/TB SEG-XXX-BMB-HV/TB SEG-XXX-6MA-HV/TB SEG-XXX-6PA-HV/TB SEG-XXX-BMA-HV/TB SEG-XXX-BMZ-HV/TB				
Type 2 182	SEG-XXX-BMD-HV/TB SEG-XXX-BTD-HV/TB SEG-XXX-BMA-HV/TB SEG-XXX-BTA-HV/TB	+5400/-2400			<p>4 mounting holes</p>
Type 3 210	SEG-XXX-BMC-HV/TB SEG-XXX-BTC-HV/TB SEG-XXX-BMB-HV/TB SEG-XXX-BTB-HV/TB				

Table 2

3.4 CLAMP INSTALLATION

The single glass module with frame is also designed for clamp installation. It needs the clamps, bolts, nuts and washers to fix on the bracket(as shown in Figure 4 and Figure 5). Sufficient torque should be applied to the bolts to ensure stable reinforcement. The reference torque value for M8 screw is 16~20N*M.



Figure 2 Double-side clamp



Figure 3 Single-side clamp

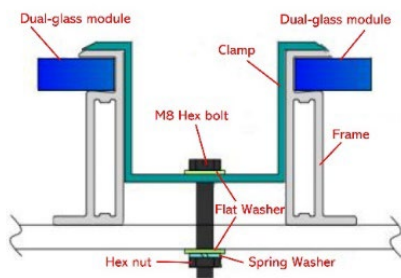

Figure 4 Double-side clamp installation

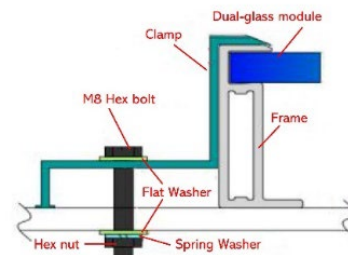
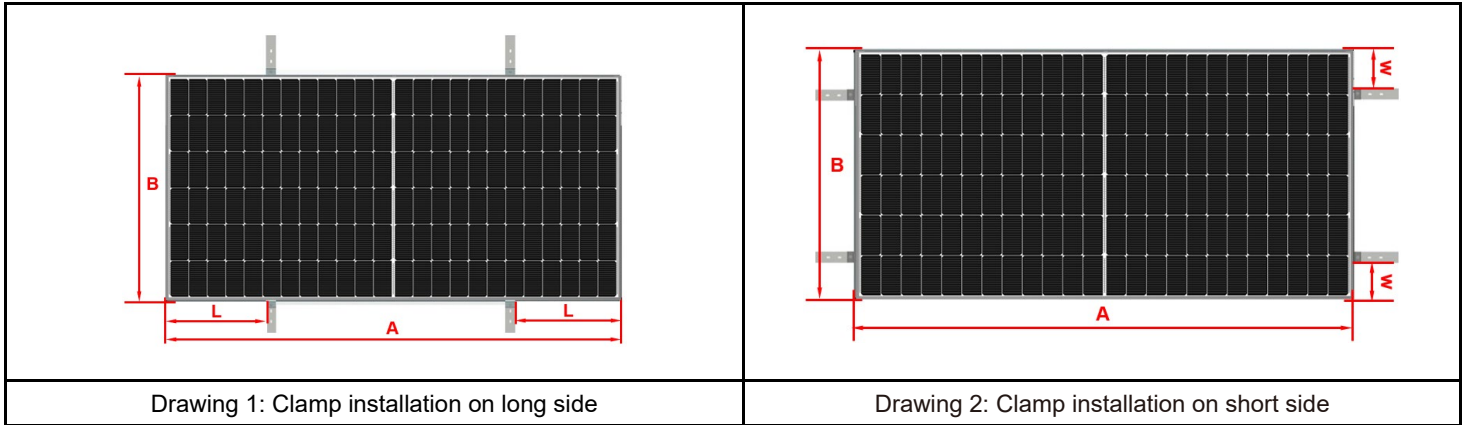

Figure 5 Single-side clamp installation



Module type		Installation Drawing 1			Installation Drawing 2									
		Clamp Length	L (mm)	Load (Pa)	Clamp Length	W (mm)	Load (Pa)							
Type 1 166	SEG-XXX-BMB-HV/TB(1755×1038×35)	≥50mm	A/8~A/4	+5400/-2400	≥50mm	B/8~B/4	+3600/-2400							
			50~500	+3600/-2400										
	SEG-XXX-BMA-HV/TB(2095×1038×35)	≥50mm	A/8~A/4	+5400/-2400										
			50~500	+3600/-2400										
Type 2 182	SEG-XXX-BMD-HV/TB(1722×1134×35) SEG-XXX-BTD-HV/TB(1722×1134×35)	≥50mm	A/8~A/4	+5400/-2400	≥50mm	B/8~B/4	+3600/-2400							
			50~500	+3600/-2400										
	SEG-XXX-BMB-HV/TB(1909×1134×35) SEG-XXX-BTB-HV/TB(1909×1134×35)	≥50mm	A/8~A/4	+5400/-2400										
			50~500	+3600/-2400										
	SEG-XXX-BMA-HV/TB(2278×1134×35) SEG-XXX-BTA-HV/TB(2278×1134×35)	≥50mm	A/8~A/4	+5400/-2400										
			50~500	+3600/-2400										
Type 3 210	SEG-XXX-BMC-HV/TB(2384×1303×35) SEG-XXX-BTC-HV/TB(2384×1303×35)	≥80mm	A/8~A/4	+5400/-2400	≥80mm	B/8~B/4	+2400/-2400							
	SEG-XXX-BMB-HV/TB(2172×1303×35) SEG-XXX-BTB-HV/TB(2172×1303×35)													
	Type 4 156& 158.75							SEG-XXX-6MB-HV/TB(1665×1002×35) SEG-XXX-6PB-HV/TB(1665×1002×35)	≥50mm	A/8~A/4	+5400/-2400	≥50mm	B/8~B/4	+3600/-2400
								SEG-XXX-6MA-HV/TB(1985×1002×35) SEG-XXX-6PA-HV/TB(1985×1002×35)						
SEG-XXX-BMB-HV/TB(1690×1002×35)														
SEG-XXX-BMA-HV/TB(2015×1002×35)														
SEG-XXX-BMZ-HV/TB(2198×1008×30)														

Table 3

3.5 TRACKER INSTALLATION

SEG modules also have compatibility with tracker systems in the industry. The maximum load that SEG module can achieve is listed in Table 4. (For detailed installation drawings and installation method, please refer to installation manual of tracker supplier.)

Module type		Tracker system	Installation	Load (Pa)
Type 1 166	SEG-XXX-BMA-HV/TB	Nexttracker	400mm hole distance	+2400/-2400
Type 2 182	SEG-XXX-BMA-HV/TB	Nexttracker	400mm hole distance	+2400/-2400
	SEG-XXX-BTA-HV/TB		790mm hole distance	+3150/-2550
Type 3 210	SEG-XXX-BMC-HV/TB	Nexttracker	400mm hole distance	+2400/-2400
	SEG-XXX-BTC-HV/TB		790mm hole distance	+3150/-2550
	SEG-XXX-BMB-HV/TB			
	SEG-XXX-BTB-HV/TB			
Type 4 156&158.75	SEG-XXX-6MA-HV/TB	Nexttracker	400mm hole distance	+2400/-2400
	SEG-XXX-6PA-HV/TB			
	SEG-XXX-BMA-HV/TB			
	SEG-XXX-BMZ-HV/TB			

Table 4

3.6 OTHER INSTALLATION

Method A: six clamps installation

SEG provides a special installation method that installs six clamps on the long side of the frame(as shown in Drawing 3). It is recommended to use a clamp with length of ≥ 80 mm and thickness of ≥ 4 mm, aluminum alloy 6005-T6.

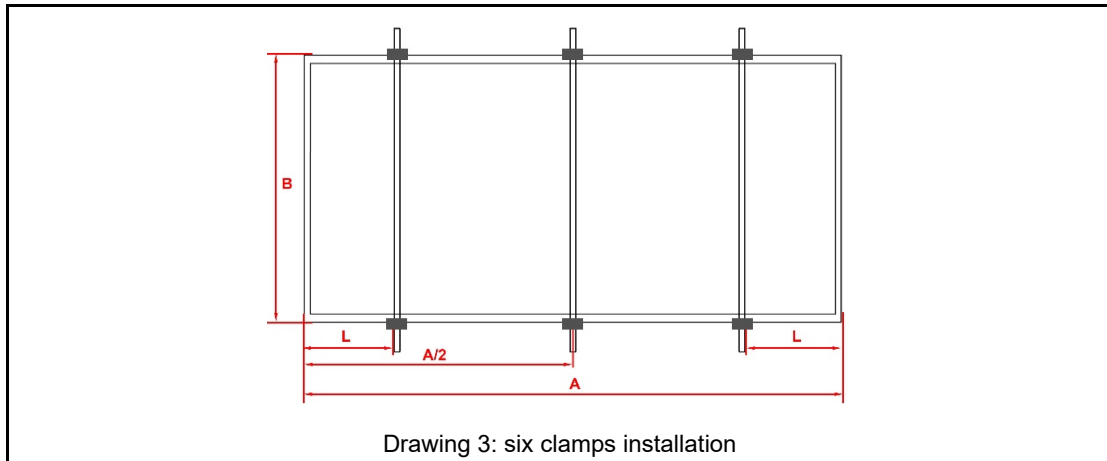

Drawing 3: six clamps installation

Module type		Clamp length	L (mm)	Load (Pa)
Type 2 182	SEG-XXX-BMA-HV/TB(2278×1134×35)	≥ 80 mm	A/8~A/4	+5400/-3600
	SEG-XXX-BTA-HV/TB(2278×1134×35)			

Table 5

Method B: four screws add four clamps installation

SEG provides a special installation method that installs four screws and at the same location add four clamps on the long side of the frame(as shown in Drawing 4).

The screws with 4 holes are recommend to use special rectangular washers(as shown in Fig 6). The minimum thickness of the washer is 2 mm. It is also recommended to use a clamp with length of ≥ 80 mm and thickness of ≥ 4 mm, aluminum alloy 6005-T6.

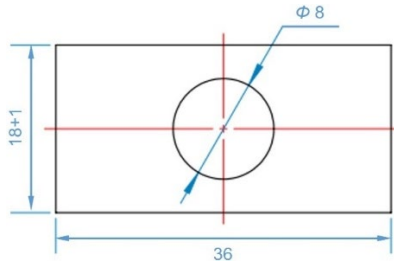
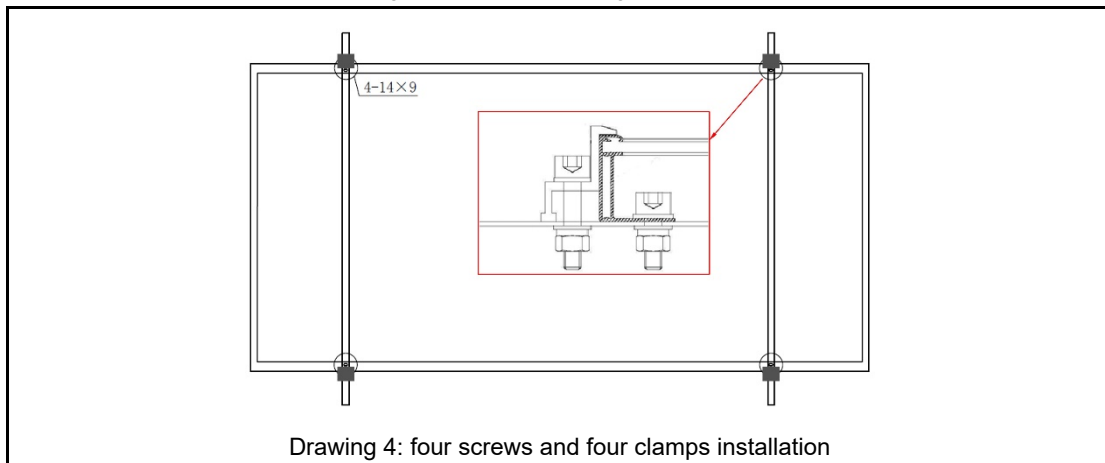

Figure 6 Special rectangular washer



Drawing 4: four screws and four clamps installation

Module type		Clamp length	Load (Pa)
Type 2	SEG-XXX-BMA-HV/TB(2278×1134×35)	≥ 80mm	+5400/-3600
182	SEG-XXX-BTA-HV/TB(2278×1134×35)		

Table 6

SEG provides reference installation methods for areas with high load requirements, as shown above. The system designer and the installer are responsible for correctly calculating the loads and ensuring that the supporting structure meets all the applicable requirements.

3.7 ELECTRICAL INSTALLATION



WARNING Electrical Hazard
This module produces electricity when exposed to light. Follow all applicable electrical safety precautions.

- ONLY qualified personnel can install or perform maintenance work on these PV modules.
- BE AWARE of dangerous high DC voltage when connecting module.
- DO NOT damage or scratch the rear surface of the module.
- DO NOT handle or install module when they are wet.

The wiring components shall be compatible with the PV modules.

The PV modules connected in serial shall have similar current. The Voc of one PV string shall be no higher than the maximum system voltage, the Voc temperature coefficient feature and the extreme low temperature of the installation location must be taken into consideration when calculate the Voc of the PV string.

The PV modules connected in parallel shall have similar Voltage. The I_{sc} temperature coefficient feature and the extreme high temperature of installation location must be taken into consideration when calculate the I_{sc} of the PV array.

Please refer to local regulations to determine the system wire's size, type, and temperature.

The cross-sectional area and cable connector capacity must satisfy the maximum short-circuit of PV system (For a single component, we recommended the cross-sectional area of cables is 4mm^2 and the rated current of connectors is more than 15A), otherwise cables and connectors will become overheating for large current. Please pay attention: the temperature limit of cables is 85°C and the temperature limit of the connector is 105°C .

A qualified system designer or integrator should always be consulted.

Building permits, inspections, and approvals by the local utility are generally required.

Before installation, make sure that the connector is well protected and there should be no foreign matter such as soil, sand, and gravel in the connector. If any, it must be cleaned before installation. If the connector is damaged or deformed, the connector must be replaced before use; if there is no spare connector, please contact SEG in time.

Remark: If conversion cable is needed, see table 1 for details.

3.8 GROUNDING

All module frames must be properly grounded.

Observe all local electric codes and regulations.

A bonding or toothed washer is required to make proper and reliable electrical grounding connection with the anodized aluminum frame.

Devices listed and identified for grounding metallic frames of PV modules are permitted to ground the exposed metallic frames of the module to grounded mounting structures.

Consider using a lay-in lug, rated for outdoor use, if the module grounding conductor is to be larger than 10 AWG.

When using lay-in lugs, the grounding conductor should be inserted into the opening indicated in figure 6, and secured using the set screw.

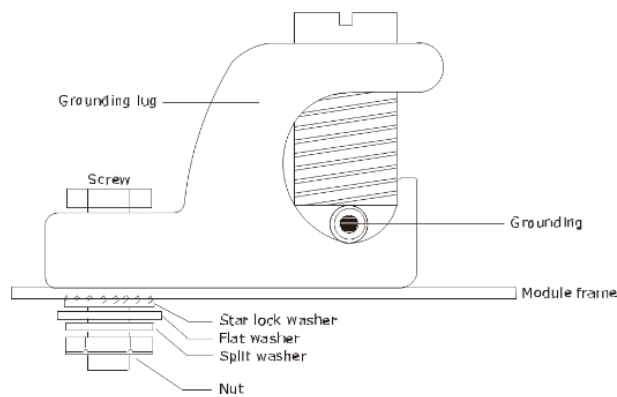

Figure 6 Grounding installation of PV module

Except for equipment grounding, SEG recommends the negative pole of PV module array is connected to earth during all PV system installations. That will keep optimal performance of PV Power Plants, which are located in a hot, high humidity climate and high Maximum System Voltage.

To acquire the best power output, SEG recommends clients install modules with anti-PID inverters.

4 MAINTENANCE

SEG Solar recommends the following maintenance items to ensure optimal performance of the module.

Caution: observe the maintenance instructions for all components used in the system, such as support frames, charging regulators, inverters, batteries, etc.

4.1 CLEANING

SEG Solar PV modules require proper cleaning procedures to ensure optimal performance. Professional installers must read and follow these guidelines carefully to prevent death, injury, or property damage. Inappropriate cleaning procedures can void the SEG Solar warranty.

When cleaning the modules, ensure that the water temperature is within the range of -5°C to 10°C compared to the module temperature. Use a soft and clean cloth, sponge, or soft-bristled brush to wipe the photovoltaic module. Avoid using cleaning tools that can wear out glass, EPDM, silicon, aluminum alloys, or steel. For greasy dirt or other stubborn substances, use conventional household glass cleaning agents. However, avoid using alkaline and strong acidic solvents like hydrofluoric acid, alkali, or acetone.

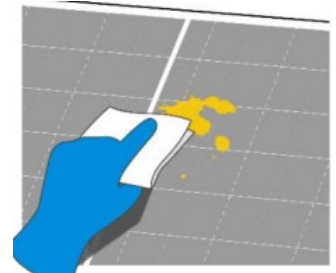

If the modules are installed horizontally (0° tilt angle), they need to be cleaned more frequently since they lack the "self-cleaning" function of those installed at 10° or larger tilt angles. The back surface of monofacial modules usually does not require cleaning. However, when cleaning the back of the bifacial module, avoid using sharp objects that may cause damage or penetrate the base material. All other cleaning requirements for the back surface are the same as the front side.

When cleaning solar panels, there is a risk of damaging the modules and array components which can increase the potential hazard of electric shock. Therefore, do not clean the modules during the hottest time of the day as this can cause thermal stress on the modules. Additionally, cracked or broken modules can also result in electric shock due to leakage currents. To avoid this, thoroughly inspect the modules for cracks, damage, and loose connections before cleaning.

Furthermore, it's recommended to wear suitable protective clothing, such as insulating gloves, while cleaning the modules. However, do not immerse the modules, either partially or totally, in water or any other cleaning solutions. Also, avoid using lubricants and organic solvents to clean the connectors.

When cleaning the modules, avoid stepping on them and do not inject water into the backside of the modules or cables. It is important to keep the connectors clean and dry to prevent electric shock and fire hazards.

CLEANING METHODS

Method A: Compressed Water

Water Quality Requirements:

pH: between 6 and 8

Calcium Carbonate Concentration (Water Hardness): 600 mg/L or less

It is recommended to use soft water for washing.

The maximum recommended water pressure is 4 MPa (40 bar).

Method B: Compressed Air

SEG Solar recommends using compressed air to clean soft dirt such as dust from solar modules. However, this method should only be used if it is effective enough to clean the modules considering the on-site conditions.

Method C: Wet Cleaning

If there is excessive soiling on the module surface, a mild agitating method like a non-conductive brush or sponge can be used with caution. It is important to ensure that any brushes or agitating tools are made of non-conductive materials to minimize the risk of electric shock. Also, they should not be abrasive to the glass or aluminum frame. In case of grease, an environmentally friendly cleaning agent may be used with caution.

Method D: Cleaning Robot

If a cleaning robot is used for dry cleaning, it should have a soft plastic brush material that won't scratch the glass surface or aluminum alloy frame of the module during and after the cleaning process. Additionally, the weight of the cleaning robot should not be too heavy. It is important to use the cleaning robot properly as any resulting module damage or power attenuation will not be covered by SEG Solar's warranty.

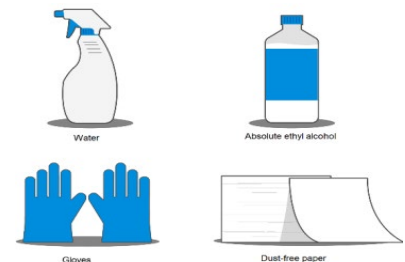

4.2 THE VISUAL INSPECTION OF THE MODULES

Inspect the modules visually to find if there are appearance defects, especially:

- Whether the module glass is broken.
- If there is burning vestige on the backsheet.
- Corrosion along the cells' bus-bar. The corrosion is caused by the dampness infiltrated into the modules when the surface encapsulation material is damaged during the installation or transportation.
- Check if any obstacles shading the PV modules.

4.3 INSPECTION OF THE CONNECTOR AND CABLE

- Check the encapsulation of the connector with the cable
- Check the sealing gel of the junction box to ensure it is not cracked or creviced.

Please ensure that all cables are firmly connected and kept away from water areas and direct sunlight.

5 PARAMETERS

The parameters may be updated from time to time, accurate parameters please check on our website: <http://www.segsolar.com> or email our technical support team: technic@segsolar.com.



SEG SOLAR INC.

Email: info@segsolar.com

Web: www.segsolar.com

SEG Headquarters: 10625 Telge Road, Houston, TX 77095